

tend HOIST PUSH BUTTON SWITCH

สวิตช์คอน ชนิตรรรมดา

CHARACTERISTICS

Type	Label	Button	Button assembly	Description	Exterminal diameter of cable	Terminal	Remark	Price	
THS-EP213	None	1	T2BKRR-2B	Emergency stop 2B (red)	10 A 250 V AC	Ø13.3 ~ Ø16.5	M3.5	Control motor directly	1,540.-
		2	T2PR-2R	Indicator (Red)	220 V AC				
		3	THS-213C	213 contact block	Single 100/110 V 0.75 Kw Phase 200/220 V 1.5 Kw				
		4							
THS-EI22	A	1	T2BKRR-1B	Emergency stop 1B (red)	10 A 250 V AC	Ø13.3 ~ Ø16.5	M3.5	Control motor directly	2,200.-
		2	T2IFR2G-1A	illuminated flat head push button switch 1A (green)	220 V AC				
		3	THS-2C-S	21 contact block	Single 200/220 V 2.2 Kw Phase 400/440 V 2.2 Kw				
		4							
THS-EI23	E	1	T2BKRR-1B	Emergency stop 1B (red)	10 A 250 VAC	Ø16.3 ~ Ø19.5	M3.5	Control motor directly	3,070.-
		2	T2IFR2G-1A	illuminated flat head push button switch 1A (green)	220 VAC				
		3 4	2*THS-2C-S	21 contact block*2	Single 200/220 V 2.2 Kw Phase 400/440 V 2.2 Kw				
		5 6							

● Note : None-represent Chinese sticker (A: represents the arrow sticker E: represents English sticker)

DIMENSIONS AND WIRING DRAWING



tend HOIST PUSH BUTTON SWITCH

สวิตช์ครน ชนิดรรมดา

■ DIRECT OPERATION TYPE ชนิดต่อตรง



■ DIRECT OPERATION TYPE ชนิดต่อผ่านเมกเนติกสวิตช์



The hoist push button switches are classified as follows in accordance with application.

Direct operation

1. Hoisting (One set of forward and reverse)
2. Hoisting transverse, or longitudinal (two sets of forward and reverse)
3. Hoisting, transverse, and longitudinal (three sets of forward and reverse)

In conjunction with a magnetic switch

4. Hoisting (one set of forward and reverse used in conjunction with a magnetic switch)
5. Two sets and three sets of forward and reverse are planned.

Used Direct Operation		With A Magnetic Switch	
250 V	15 A	250 V	5 A
500 V	15 A	500 V	2 A

■ SPECIFICATIONS

Type	Hoist operation	Maximum applicable electric motor capacity 200/220V kW (HP)	Standard			Special	
			Inner diameter of the glad bushing packing (mm)	Nominal crosssectional area (mm ²)	Number of conductors	Other special rubber cables	
Direct operation	THS-213L	0.75 (1) 1Ø100V With Lock Pin	18	2.0	6	2 mm ² , 4-Conductor, vinyl, 12Ø	
	THS-213	0.75 (1) 1Ø 100V	18	2.0	6		
	THS-21	2.2 (3)	16	2.0	5		
	THS-22	Hoisting and transverse (or longitudinal)	2.2 (3) x 2	18	2.0	7	2 m ² , 9-Conductor, rubber, 19Ø
	THS-23	Hoisting transverse and longitudinal	2.2 (3) x 3	14-1, 16-1	2.0	4 and 5	2 mm ² , 7-Conductor, Chloroprene, 17Ø
Indirect operation	THS-61	250 V 5A	12	2.0	3	10Ø, 11Ø, 13Ø	
	THS-62	500 V 2A	16	2.0	6		
	THS-63	with a magnetic switch	18	2.0	7		

tend HOIST PUSH BUTTON SWITCH







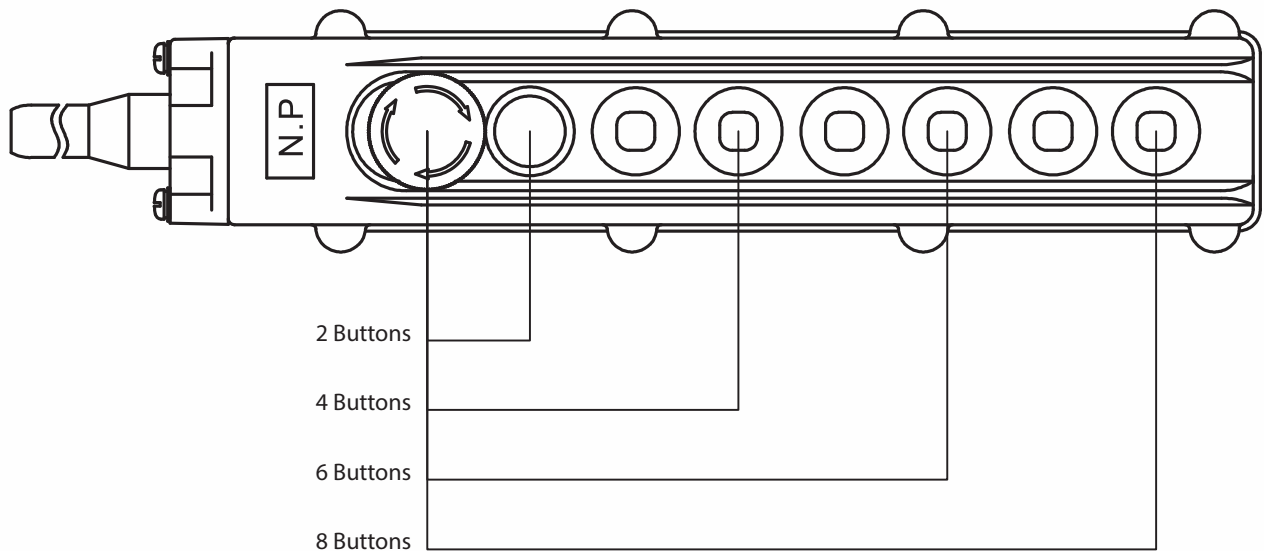

สวิตช์เคส IP67

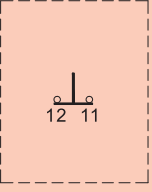
■ MODEL DESIGNATION

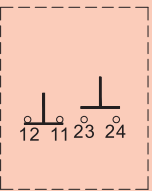

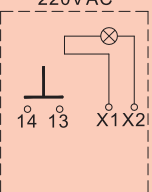
THS-8	2				for 2 buttons
THS-8	2	2			for 4 buttons
THS-8	2	2	2		for 6 buttons
THS-8	EP	2	2	2	for 8 buttons

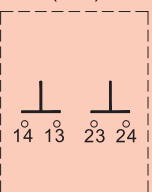
Designation	Signal	Description
Control method	82	Direct control 3Ø Single speed
	83	Indirect control Two speed
	86	Indirect control Single speed
Push button sw.	EX	Emergency stop + Water proof rubber
	EB	Emergency stop + Push button switch
	EI	Emergency stop + Illuminated Push button switch
	EK	Emergency stop + Key switch
	EP	Emergency stop + Indicator
	ES	Emergency stop + Selector switch

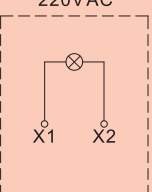

Type no.	Picture	Contact	Price
E	<p>สวิตช์กดดอกเห็ด THS-BKR</p> 	<p>(1b)</p> 	245.-
B	<p>สวิตช์กด THS-BFR</p> 	<p>(1a1b)</p> 	150.-
I	<p>สวิตช์มีไฟล๊อตแอมป์ THS-IFR</p> 	<p>(1a) 220VAC</p> 	270.-
K	<p>สวิตช์กุญแจ THS-KSR</p> 	<p>(2a)</p> 	565.-
P	<p>ไฟล๊อตแอมป์ THS-PR</p> 	<p>220VAC</p> 	180.-

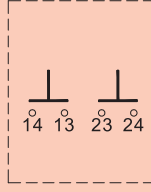
หมายเหตุ นอกเหนือจาก Spec สำหรับรูปใน Price list นี้ ท่านสามารถซื้ออะไหล่ประกอบเองหรือให้ทางบริษัทประกอบให้ตาม Spec ที่ต้องการ

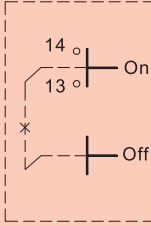
Type no.	Picture	Contact	Price
S	<p>สวิตช์ลูกศร THS-SSR</p> 	<p>(2a)</p> 	210.-
X	<p>ตัวอุด THS-X</p> 	<p>2*TP4*8 Screw Blanking Plate</p>	42.-
PB	<p>สวิตช์กด ON - OFF THS-PB</p> 	<p>(1a)</p> 	335.-

■ STICKER WITH LENS 5HS8C02

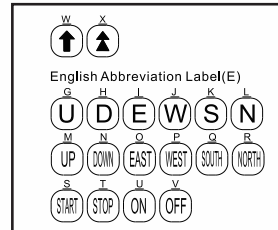

ราคาแผ่นละ 20.-

- THS-81-B-BOX FOR 2 BUTTON บ็อกสวิตช์กระแส 2 ช่อง 340.-
- THS-82-B-BOX FOR 4 BUTTON บ็อกสวิตช์กระแส 4 ช่อง 660.-
- THS-83-B-BOX FOR 6 BUTTON บ็อกสวิตช์กระแส 6 ช่อง 1,000.-
- THS-84-B-BOX FOR 8 BUTTON บ็อกสวิตช์กระแส 8 ช่อง 1,340.-
- THS-82-C CONTACT DIRECT OPERATION SINGLE SPEED คอนแทค 1 สปีดชนิดต่อตรง สำหรับรุ่น THS-82 1,340.-
- THS-83-C CONTACT INDIRECT OPERATION DOUBLE SPEED คอนแทค 2 สปีดชนิดต่อผ่านเมกเนติกสวิตช์ สำหรับรุ่น THS-83 2,340.-
- THS-86-C CONTACT INDIRECT OPERATION SINGLE SPEED คอนแทค 1 สปีดชนิดต่อผ่านเมกเนติกสวิตช์ สำหรับรุ่น THS-86 335.-

tend**HOIST PUSH BUTTON SWITCH**

สวิตช์คอน IP67

INDIRECT OPERATION TYPE สวิตช์คอนชนิดต่อผ่านเมกเนติกสวิตช์

	P/N	Description	Contact	Spec.	Remark	Price
	THS-86	Indirect Operation 2 buttons	2a	5A 250V AC	Rainproof	600.-
WIND SPEED	THS-866	Indirect Operation 4 buttons	4a	5A 250V AC	Rainproof	1,050.-
	THS-8666	Indirect Operation 6 buttons	6a	5A 250V AC	Rainproof	1,450.-
COMMAX	THS-86666	Indirect Operation 8 buttons	8a	5A 250V AC	Rainproof	2,830.-
	THS-8PB6	Indirect Operation 2 buttons with P.B.SW. on-Off	2a	5A 250V AC	Rainproof	1,470.-
	THS-8PB66	Indirect Operation 4 buttons with P.B.SW. on-Off	4a	5A 250V AC	Rainproof	2,180.-
ADVANTE	THS-8PB666	Indirect Operation 6 buttons with P.B.SW. on-Off	6a	5A 250V AC	Rainproof	2,900.-
	THS-83	Indirect Operation Double Speed 2 buttons	2a	5A 250V AC	Rainproof	2,820.-
	THS-833	Indirect Operation Double Speed 4 buttons	4a	5A 250V AC	Rainproof	5,520.-
UNIVERSAL ADAPTER	THS-8333	Indirect Operation Double Speed 6 buttons	6a	5A 250V AC	Rainproof	8,360.-
	THS-83333	Indirect Operation Double Speed 8 buttons	8a	5A 250V AC	Rainproof	10,960.-
ALION	THS-8PB3	Indirect Operation Double Speed 2 buttons with P.B.SW. on-off	2a	5A 250V AC	Rainproof	3,470.-
	THS-8PB33	Indirect Operation Double Speed 4 buttons with P.B.SW. on-off	4a	5A 250V AC	Rainproof	6,200.-
	THS-8PB333	Indirect Operation Double Speed 6 buttons with P.B.SW. on-off	6a	5A 250V AC	Rainproof	8,810.-
EXOWELD	THS-836	Double Speed 2 buttons Single Speed 2 buttons	2a	5A 250V AC	Rainproof	3,510.-
	THS-8366	Double Speed 2 buttons Single Speed 4 buttons	4a	5A 250V AC	Rainproof	4,230.-
	THS-8336	Double Speed 4 buttons Single Speed 2 buttons	6a	5A 250V AC	Rainproof	6,230.-
CONTROL MAX	THS-83666	Double Speed 2 buttons Single Speed 6 buttons	6a	5A 250V AC	Rainproof	4,940.-
	THS-83366	Double Speed 4 buttons Single Speed 4 buttons	6a	5A 250V AC	Rainproof	6,950.-
	THS-83336	Double Speed 6 buttons Single Speed 2 buttons	8a	5A 250V AC	Rainproof	8,950.-
JKN	THS-8EX3	Double Speed 2 buttons With Emergency Stop	2a	5A 250V AC	Rainproof	3,420.-
	THS-8EB3	Double Speed 2 buttons With Emergency Stop, P.B. SW	2a	5A 250V AC	Rainproof	3,530.-
	THS-8EI3	Double Speed 2 buttons With Emergency Stop, I. P.B SW	2a	5A 250V AC	Rainproof	3,630.-
SYLVIA	THS-8EK3	Double Speed 2 buttons With Emergency Stop & Key Sw.	2a	5A 250V AC	Rainproof	3,950.-
	THS-8EP3	Double Speed 2 buttons With Emergency Stop & Pilot Lamp	2a	5A 250V AC	Rainproof	3,560.-
WANG	THS-8ES3	Double Speed 2 buttons With Emergency Stop & Selector	2a	5A 250V AC	Rainproof	3,600.-

*ขอสงวนสิทธิ์ในการเปลี่ยนแปลงราคา



■ **INDIRECT OPERATION TYPE** สวิตช์เครนชนิดต่อผ่านเมกเนติกสวิตช์

P/N	Description	Contact	Spec.	Remark	Price
THS-8EX36	D.S.2 buttons, S.S. 2 buttons / E. STOP	2a/2a	5A 250V AC	Rainproof	4,140.-
THS-8EB36	D.S.2 buttons, S.S. 2 buttons / E. STOP, P.B., SW.	2a/2a	5A 250V AC	Rainproof	4,250.-
THS-8EI36	D.S.2 buttons, S.S. 2 buttons / E. STOP, I.P.B., SW.	2a/2a	5A 250V AC	Rainproof	4,370.-
THS-8EK36	D.S.2 buttons, S.S. 2 buttons / E. STOP, Key., SW.	2a/2a	5A 250V AC	Rainproof	4,660.-
THS-8EP36	D.S.2 buttons, S.S. 2 buttons / E. STOP, Pilot Lamp	2a/2a	5A 250V AC	Rainproof	4,280.-
THS-8ES36	D.S.2 buttons, S.S. 2 buttons / E. STOP, Selector	2a/2a	5A 250V AC	Rainproof	4,310.-
THS-8EX33	D.S.4 buttons, B1 / E. STOP	4a	5A 250V AC	Rainproof	6,150.-
THS-8EB33	D.S.4 buttons / E. STOP, P.B., SW.	4a	5A 250V AC	Rainproof	6,250.-
THS-8EI33	D.S.4 buttons / E. STOP, I.P.B., SW.	4a	5A 250V AC	Rainproof	6,370.-
THS-8EK33	D.S.4 buttons / E. STOP, Key., SW.	4a	5A 250V AC	Rainproof	6,670.-
THS-8EP33	D.S.4 buttons / E. STOP, Pilot Lamp	4a	5A 250V AC	Rainproof	6,280.-
THS-8ES33	D.S.4 buttons / E. STOP, Selector	4a	5A 250V AC	Rainproof	6,210.-
THS-8EX336	D.S.4 buttons, S.S. 2 buttons / E. STOP	4a/2a	5A 250V AC	Rainproof	6,860.-
THS-8EB336	D.S.4 buttons, S.S. 2 buttons / E. STOP, P.B., SW.	4a/2a	5A 250V AC	Rainproof	6,970.-
THS-8EI336	D.S.4 buttons, S.S. 2 buttons / E. STOP, I.P.B., SW.	4a/2a	5A 250V AC	Rainproof	7,090.-
THS-8EK336	D.S.4 buttons, S.S. 2 buttons / E. STOP, Key., SW.	4a/2a	5A 250V AC	Rainproof	7,380.-
THS-8EP336	D.S.4 buttons, S.S. 2 buttons / E. STOP, Pilot Lamp	4a/2a	5A 250V AC	Rainproof	7,000.-
THS-8ES336	D.S.4 buttons, S.S. 2 buttons / E. STOP, Selector	4a/2a	5A 250V AC	Rainproof	7,030.-
THS-8EX333	THS-8EX333 D.S.6 buttons, B1 / E. STOP	6a	5A 250V AC	Rainproof	8,870.-
THS-8EB333	D.S.6 buttons / E. STOP, P.B., SW.	6a	5A 250V AC	Rainproof	8,970.-
THS-8EI333	D.S.6 buttons / E. STOP, I.P.B., SW.	6a	5A 250V AC	Rainproof	9,090.-
THS-8EK333	D.S.6 buttons / E. STOP, Key., SW.	6a	5A 250V AC	Rainproof	9,390.-
THS-8EP333	D.S.6 buttons / E. STOP, Pilot Lamp	6a	5A 250V AC	Rainproof	9,000.-
THS-8ES333	D.S.6 buttons / E. STOP, Selector	6a	5A 250V AC	Rainproof	9,030.-
THS-8EX366	D.S.2 buttons, S.S. 4 buttons / E. STOP	2a/4a	5A 250V AC	Rainproof	4,860.-
THS-8EB366	D.S.2 buttons, S.S. 4 buttons / E. STOP, P.B., SW.	2a/4a	5A 250V AC	Rainproof	4,960.-
THS-8EI366	D.S.2 buttons, S.S. 4 buttons / E. STOP, I.P.B., SW.	2a/4a	5A 250V AC	Rainproof	5,080.-
THS-8EK366	D.S.2 buttons, S.S. 4 buttons / E. STOP, Key., SW.	2a/4a	5A 250V AC	Rainproof	5,380.-
THS-8EP366	D.S.2 buttons, S.S. 4 buttons / E. STOP, Pilot Lamp	2a/4a	5A 250V AC	Rainproof	4,990.-
THS-8ES366	D.S.2 buttons, S.S. 4 buttons / E. STOP, Selector	2a/4a	5A 250V AC	Rainproof	5,020.-

tend HOIST PUSH BUTTON SWITCH

สวิตช์เครน IP67



INDIRECT OPERATION TYPE สวิตช์เครนชนิดต่อผ่านเมกเนติกสวิตช์

	P/N	Description	Contact	Spec.	Remark	Price
	THS-8EX6	Indirect 2 buttons / E. STOP	2a	5A 250V AC	Rainproof	1,420.-
WIND SPEED	THS-8EB6	Indirect 2 buttons / E. STOP, P.B., SW.	2a	5A 250V AC	Rainproof	1,200.-
	THS-8EI6	Indirect 2 buttons / E. STOP, I.P.B., SW.	2a	5A 250V AC	Rainproof	1,650.-
	THS-8EK6	Indirect 2 buttons / E. STOP, Key., SW.	2a	5A 250V AC	Rainproof	1,950.-
COMMAX	THS-8EP6	Indirect 2 buttons / E. STOP, Pilot Lamp	2a	5A 250V AC	Rainproof	1,580.-
	THS-8ES6	Indirect 2 buttons / E. STOP, Selector	2a	5A 250V AC	Rainproof	1,590.-
ADVANTE	THS-8EX66	Indirect 4 buttons / E. STOP	4a	5A 250V AC	Rainproof	2,140.-
	THS-8EB66	Indirect 4 buttons / E. STOP, P.B., SW.	4a	5A 250V AC	Rainproof	2,240.-
	THS-8EI66	Indirect 4 buttons / E. STOP, I.P.B., SW.	4a	5A 250V AC	Rainproof	2,360.-
UNIVERSAL ADAPTER	THS-8EK66	Indirect 4 buttons / E. STOP, Key., SW.	4a	5A 250V AC	Rainproof	2,660.-
	THS-8EP66	Indirect 4 buttons / E. STOP, Pilot Lamp	4a	5A 250V AC	Rainproof	2,270.-
	THS-8ES66	Indirect 4 buttons / E. STOP, Selector	4a	5A 250V AC	Rainproof	2,300.-
ALION	THS-8EX666	Indirect 6 buttons / E. STOP	6a	5A 250V AC	Rainproof	2,810.-
	THS-8EB666	Indirect 6 buttons / E. STOP, P.B., SW.	6a	5A 250V AC	Rainproof	2,960.-
	THS-8EI666	Indirect 6 buttons / E. STOP, I.P.B., SW.	6a	5A 250V AC	Rainproof	3,080.-
EXOWELD	THS-8EK666	Indirect 6 buttons / E. STOP, Key., SW.	6a	5A 250V AC	Rainproof	3,380.-
	THS-8EP666	Indirect 6 buttons / E. STOP, Pilot Lamp	6a	5A 250V AC	Rainproof	2,990.-
CONTROL MAX	THS-8ES666	Indirect 6 buttons / E. STOP, Selector	6a	5A 250V AC	Rainproof	3,020.-

tend

HOIST PUSH BUTTON SWITCH

สวิตช์เครน IP67



■ DIRECT OPERATION TYPE สวิตช์เครนชนิดต่อถง

P/N	Description	Contact	Spec.	Remark	Price
THS-82	Direct Operation 2 buttons single phases	3a	15A 250V AC	Rainproof	1,400.-
THS-822	Direct Operation 4 buttons single phases	6a	15A 250V AC	Rainproof	2,670.-
THS-8222	Direct Operation 6 buttons single phases	9a	15A 250V AC	Rainproof	4,000.-
THS-82222	Direct Operation 8 buttons single phases	12a	15A 250V AC	Rainproof	6,960.-
THS-8PB2	Direct Operation 2 buttons single phases with P.B. SW. On-off	3a	15A 250V AC	Rainproof	2,470.-
THS-8PB22	Direct Operation 4 buttons single phases with P.B. SW. On-off	6a	15A 250V AC	Rainproof	4,200.-
THS-8PB222	Direct Operation 6 buttons single phases with P.B. SW. On-off	9a	15A 250V AC	Rainproof	5,910.-
THS-8EX2	Direct Operation 2 buttons with E. STOP single phases		15A 250V AC	Rainproof	2,420.-
THS-8EB2	Direct 2 buttons / E. STOP, P.B., SW. single phases		15A 250V AC	Rainproof	2,530.-
THS-8EI2	Direct 2 buttons / E. STOP, I.P.B., SW. single phases		15A 250V AC	Rainproof	2,650.-
THS-8EK2	Direct 2 buttons / E. STOP, Key., SW. single phases		15A 250V AC	Rainproof	2,950.-
THS-8EP2	Direct 2 buttons / E. STOP, Pilot Lamp single phases		15A 250V AC	Rainproof	2,560.-
THS-8ES2	Direct 2 buttons / E. STOP, Selector single phases		15A 250V AC	Rainproof	2,600.-
THS-8EX22	Direct Operation 4 buttons with E. STOP single phases		15A 250V AC	Rainproof	4,150.-
THS-8EB22	Direct 4 buttons / E. STOP, P.B., SW. single phases		15A 250V AC	Rainproof	4,250.-
THS-8EI22	Direct 4 buttons / E. STOP, I.P.B., SW. single phases		15A 250V AC	Rainproof	4,620.-
THS-8EK22	Direct 4 buttons / E. STOP, Key., SW. single phases		15A 250V AC	Rainproof	4,670.-
THS-8EP22	Direct 4 buttons / E. STOP, Pilot Lamp single phases		15A 250V AC	Rainproof	4,285.-
THS-8ES22	Direct 4 buttons / E. STOP, Selector single phases		15A 250V AC	Rainproof	4,310.-
THS-8EX222	Direct Operation 6 buttons with E. STOP single phases		15A 250V AC	Rainproof	5,870.-
THS-8EB222	Direct 6 buttons / E. STOP, P.B., SW. single phases		15A 250V AC	Rainproof	5,970.-
THS-8EI222	Direct 6 buttons / E. STOP, I.P.B., SW. single phases		15A 250V AC	Rainproof	6,100.-
THS-8EK222	Direct 6 buttons / E. STOP, Key., SW. single phases		15A 250V AC	Rainproof	6,390.-
THS-8EP222	Direct 6 buttons / E. STOP, Pilot Lamp single phases		15A 250V AC	Rainproof	6,000.-
THS-8ES222	Direct 6 buttons / E. STOP, Selector single phases		15A 250V AC	Rainproof	6,030.-

tend HOIST PUSH BUTTON SWITCH

สวิตช์เคาน์ IP67

■ Features

- This switch is waterproof and is made out of ABS housing. Suitable for out-door use.
- Sleek appearance, ergonomic, patented design.
- Unique mechanical interlock design, which can help prevent short-circuit.
- Two stage speeds can be set according to wiring configuration. First stage : inching, Second stage : rapid movement.
- Can be used with emergency stop, pilot lamp, push button switch, selector switch, key switch versatile. Selector switch rated current is 1th = 10A.
- Single speed and double speed can be chosen alternatively.

■ Characteristics

Type	Spec	External diameter of cable		Terminal	Remarks
THS94C	2A 500VAC	Two holes	Ø11.4~Ø12.6	M4	Control magnetic switch
	5A 250VAC				
THS96C	2A 500VAC	Four holes	Ø14.3~Ø15.5		
	5A 250VAC	Six holes	Ø17.2~Ø18.4		

■ Model Description

	One-two holes	Three-four holes	Five-six holes	Seven-eight holes	Label
THS-9	4				None
THS-9	4	4			A
THS-9	6	6	6		
THS-9	EP	6	6	6	E

Designation	Signal	Description
Control type	4	Indirect Double Speed (Mechanical Interlock)
	6	Indirect Single Speed
Push button (ref page TA103)	EX	Emergency Stop + Waterproof Rubber
	EB	Emergency Stop + Flat Push Button Switch
	EI	Emergency Stop + Illuminated Push Button Switch
	EK	Emergency Button + Key Switch
	EP	Emergency Stop + Pilot Lamp
	ES	Emergency Stop + Selector Switch

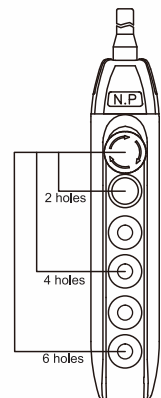

Note 1 : "None" means Chinese lable, A represents Arrow label, E represents English label see page TA121.

Note 2 : Indirect Double Speed is represented by Double Arrow labels, without additional notation of the label code A.



THS-94 □

THS-944 □

THS-9466 □

THS-9EI466 □

tend HOIST PUSH BUTTON SWITCH





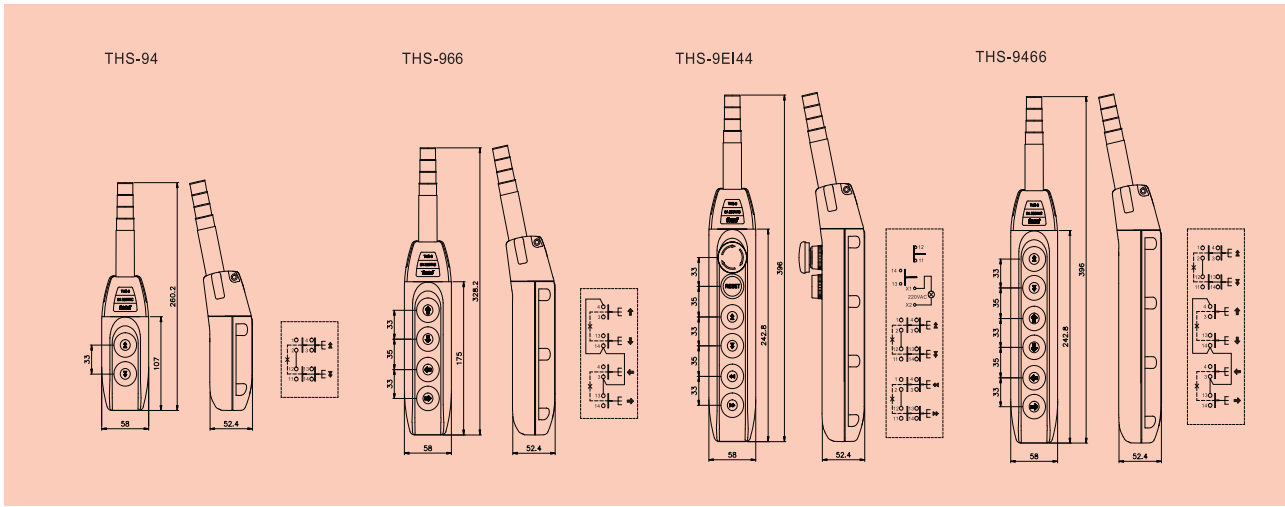

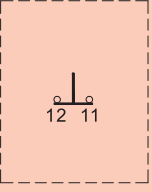

สวิตช์คอน IP67

■ DIMENSIONS AND WIRING DIAGRAMS

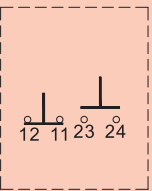

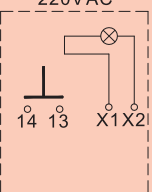

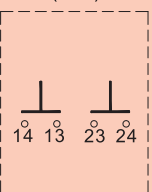
■ INDIRECT OPERATION TYPE สวิตช์คอน ชนิดต่อผ่านเมนเทคสวิตช์

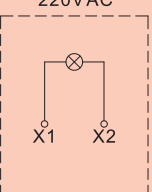
P/N	Description	Contact	Spec.	Remark	Price
THS-96	Indirect operation 2 buttons	2A	5A 250 V AC	Rainproof	650.-
THS-966	Indirect operation 4 buttons	4A	5A 250 V AC	Rainproof	1,200.-
THS-9EX6	Indirect operation 2 buttons with emergency stop	2A	5A 250 V AC	Rainproof	1,500.-
THS-9EB6	Indirect operation 2 buttons with emergency stop & flat push button	2A	5A 250 V AC	Rainproof	1,660.-
THS-9EK6	Indirect operation 2 buttons with emergency stop & key button	2A	5A 250 V AC	Rainproof	2,050.-
THS-9EP6	Indirect operation 2 buttons with emergency stop & pilot lamp	2A	5A 250 V AC	Rainproof	1,660.-
THS-9ES6	Indirect operation 2 buttons with emergency stop & selector	2A	5A 250 V AC	Rainproof	1,680.-
THS-94	Indirect operation double speed 2 buttons	2A	5A 250 V AC	Rainproof	2,900.-
THS-944	Indirect operation double speed 4 buttons	4A	5A 250 V AC	Rainproof	5,800.-
THS-9EX4	Double speed 2 buttons with emergency	2A	5A 250 V AC	Rainproof	3,590.-
THS-9EP4	Double speed 2 buttons with emergency Stop & pilot lamp	2A	5A 250 V AC	Rainproof	3,740.-
THS-9ES4	Double speed 2 buttons with emergency stop & selector	2A	5A 250 V AC	Rainproof	3,780.-

Type no.	Picture	Contact	Price
E	<p>สวิตช์กดดอกเห็ด THS-BKR</p> 	<p>(1b)</p> 	245.-
B	<p>สวิตช์กด THS-BFR</p> 	<p>(1a1b)</p> 	150.-
I	<p>สวิตช์มีไฟล๊อตแอมป์ THS-IFR</p> 	<p>(1a) 220VAC</p> 	270.-
K	<p>สวิตช์กุญแจ THS-KSR</p> 	<p>(2a)</p> 	565.-
P	<p>ไฟล๊อตแอมป์ THS-PR</p> 	<p>220VAC</p> 	180.-

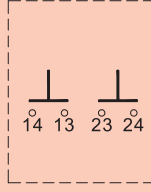
หมายเหตุ นอกเหนือจาก Spec สำหรับรูปใน Price list นี้ ท่านสามารถซื้อ อะไหล่ประกอบเองหรือให้ทางบริษัทประกอบให้ตาม Spec ที่ต้องการ

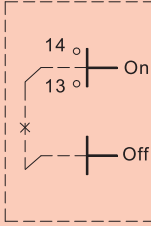
Type no.	Picture	Contact	Price
S	<p>สวิตช์ลูกศร THS-SSR</p> 	<p>(2a)</p> 	210.-
X	<p>ตัวอุด THS-X</p> 	<p>2*TP4*8 Screw Blanking Plate</p>	42.-
PB	<p>สวิตช์กด ON - OFF THS-PB</p> 	<p>(1a)</p> 	335.-

■ STICKER WITH LENS 5HS8C02

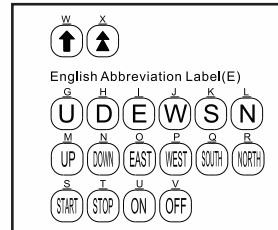

ราคาแผ่นละ 20.-

- THS-81-B-BOX FOR 2 BUTTON บ็อกสวิตช์กระแส 2 ช่อง 340.-
- THS-82-B-BOX FOR 4 BUTTON บ็อกสวิตช์กระแส 4 ช่อง 660.-
- THS-83-B-BOX FOR 6 BUTTON บ็อกสวิตช์กระแส 6 ช่อง 1,000.-
- THS-84-B-BOX FOR 8 BUTTON บ็อกสวิตช์กระแส 8 ช่อง 1,340.-
- THS-82-C CONTACT DIRECT OPERATION SINGLE SPEED คอนแทค 1 สปีดชนิดต่อตรง สำหรับรุ่น THS-82 1,340.-
- THS-83-C CONTACT INDIRECT OPERATION DOUBLE SPEED คอนแทค 2 สปีดชนิดต่อผ่านเมกเนติกสวิตช์ สำหรับรุ่น THS-83 2,340.-
- THS-86-C CONTACT INDIRECT OPERATION SINGLE SPEED คอนแทค 1 สปีดชนิดต่อผ่านเมกเนติกสวิตช์ สำหรับรุ่น THS-86 335.-

tend**HOIST PUSH BUTTON SWITCH**

สวิตช์เครน IP67

INDIRECT OPERATION TYPE สวิตช์เครนชนิดต่อผ่านเมกเนติกสวิตช์

	P/N	Description	Contact	Spec.	Remark	Price
	THS-86	Indirect Operation 2 buttons	2a	5A 250V AC	Rainproof	600.-
WIND SPEED	THS-866	Indirect Operation 4 buttons	4a	5A 250V AC	Rainproof	1,050.-
	THS-8666	Indirect Operation 6 buttons	6a	5A 250V AC	Rainproof	1,450.-
COMMAX	THS-86666	Indirect Operation 8 buttons	8a	5A 250V AC	Rainproof	2,830.-
	THS-8PB6	Indirect Operation 2 buttons with P.B.SW. on-Off	2a	5A 250V AC	Rainproof	1,470.-
	THS-8PB66	Indirect Operation 4 buttons with P.B.SW. on-Off	4a	5A 250V AC	Rainproof	2,180.-
ADVANTE	THS-8PB666	Indirect Operation 6 buttons with P.B.SW. on-Off	6a	5A 250V AC	Rainproof	2,900.-
	THS-83	Indirect Operation Double Speed 2 buttons	2a	5A 250V AC	Rainproof	2,820.-
	THS-833	Indirect Operation Double Speed 4 buttons	4a	5A 250V AC	Rainproof	5,520.-
UNIVERSAL ADAPTER	THS-8333	Indirect Operation Double Speed 6 buttons	6a	5A 250V AC	Rainproof	8,360.-
	THS-83333	Indirect Operation Double Speed 8 buttons	8a	5A 250V AC	Rainproof	10,960.-
ALION	THS-8PB3	Indirect Operation Double Speed 2 buttons with P.B.SW. on-off	2a	5A 250V AC	Rainproof	3,470.-
	THS-8PB33	Indirect Operation Double Speed 4 buttons with P.B.SW. on-off	4a	5A 250V AC	Rainproof	6,200.-
	THS-8PB333	Indirect Operation Double Speed 6 buttons with P.B.SW. on-off	6a	5A 250V AC	Rainproof	8,810.-
EXOWELD	THS-836	Double Speed 2 buttons Single Speed 2 buttons	2a	5A 250V AC	Rainproof	3,510.-
	THS-8366	Double Speed 2 buttons Single Speed 4 buttons	4a	5A 250V AC	Rainproof	4,230.-
	THS-8336	Double Speed 4 buttons Single Speed 2 buttons	6a	5A 250V AC	Rainproof	6,230.-
CONTROL MAX	THS-83666	Double Speed 2 buttons Single Speed 6 buttons	6a	5A 250V AC	Rainproof	4,940.-
	THS-83366	Double Speed 4 buttons Single Speed 4 buttons	6a	5A 250V AC	Rainproof	6,950.-
	THS-83336	Double Speed 6 buttons Single Speed 2 buttons	8a	5A 250V AC	Rainproof	8,950.-
JKN	THS-8EX3	Double Speed 2 buttons With Emergency Stop	2a	5A 250V AC	Rainproof	3,420.-
	THS-8EB3	Double Speed 2 buttons With Emergency Stop, P.B. SW	2a	5A 250V AC	Rainproof	3,530.-
	THS-8EI3	Double Speed 2 buttons With Emergency Stop, I. P.B SW	2a	5A 250V AC	Rainproof	3,630.-
SYLVIA	THS-8EK3	Double Speed 2 buttons With Emergency Stop & Key Sw.	2a	5A 250V AC	Rainproof	3,950.-
	THS-8EP3	Double Speed 2 buttons With Emergency Stop & Pilot Lamp	2a	5A 250V AC	Rainproof	3,560.-
WANG	THS-8ES3	Double Speed 2 buttons With Emergency Stop & Selector	2a	5A 250V AC	Rainproof	3,600.-

*ขอสงวนสิทธิ์ในการเปลี่ยนแปลงราคา



■ **INDIRECT OPERATION TYPE** สวิตช์เครนชนิดต่อผ่านเมกเนติกสวิตช์

P/N	Description	Contact	Spec.	Remark	Price
THS-8EX36	D.S.2 buttons, S.S. 2 buttons / E. STOP	2a/2a	5A 250V AC	Rainproof	4,140.-
THS-8EB36	D.S.2 buttons, S.S. 2 buttons / E. STOP, P.B., SW.	2a/2a	5A 250V AC	Rainproof	4,250.-
THS-8EI36	D.S.2 buttons, S.S. 2 buttons / E. STOP, I.P.B., SW.	2a/2a	5A 250V AC	Rainproof	4,370.-
THS-8EK36	D.S.2 buttons, S.S. 2 buttons / E. STOP, Key., SW.	2a/2a	5A 250V AC	Rainproof	4,660.-
THS-8EP36	D.S.2 buttons, S.S. 2 buttons / E. STOP, Pilot Lamp	2a/2a	5A 250V AC	Rainproof	4,280.-
THS-8ES36	D.S.2 buttons, S.S. 2 buttons / E. STOP, Selector	2a/2a	5A 250V AC	Rainproof	4,310.-
THS-8EX33	D.S.4 buttons, B1 / E. STOP	4a	5A 250V AC	Rainproof	6,150.-
THS-8EB33	D.S.4 buttons / E. STOP, P.B., SW.	4a	5A 250V AC	Rainproof	6,250.-
THS-8EI33	D.S.4 buttons / E. STOP, I.P.B., SW.	4a	5A 250V AC	Rainproof	6,370.-
THS-8EK33	D.S.4 buttons / E. STOP, Key., SW.	4a	5A 250V AC	Rainproof	6,670.-
THS-8EP33	D.S.4 buttons / E. STOP, Pilot Lamp	4a	5A 250V AC	Rainproof	6,280.-
THS-8ES33	D.S.4 buttons / E. STOP, Selector	4a	5A 250V AC	Rainproof	6,210.-
THS-8EX336	D.S.4 buttons, S.S. 2 buttons / E. STOP	4a/2a	5A 250V AC	Rainproof	6,860.-
THS-8EB336	D.S.4 buttons, S.S. 2 buttons / E. STOP, P.B., SW.	4a/2a	5A 250V AC	Rainproof	6,970.-
THS-8EI336	D.S.4 buttons, S.S. 2 buttons / E. STOP, I.P.B., SW.	4a/2a	5A 250V AC	Rainproof	7,090.-
THS-8EK336	D.S.4 buttons, S.S. 2 buttons / E. STOP, Key., SW.	4a/2a	5A 250V AC	Rainproof	7,380.-
THS-8EP336	D.S.4 buttons, S.S. 2 buttons / E. STOP, Pilot Lamp	4a/2a	5A 250V AC	Rainproof	7,000.-
THS-8ES336	D.S.4 buttons, S.S. 2 buttons / E. STOP, Selector	4a/2a	5A 250V AC	Rainproof	7,030.-
THS-8EX333	THS-8EX333 D.S.6 buttons, B1 / E. STOP	6a	5A 250V AC	Rainproof	8,870.-
THS-8EB333	D.S.6 buttons / E. STOP, P.B., SW.	6a	5A 250V AC	Rainproof	8,970.-
THS-8EI333	D.S.6 buttons / E. STOP, I.P.B., SW.	6a	5A 250V AC	Rainproof	9,090.-
THS-8EK333	D.S.6 buttons / E. STOP, Key., SW.	6a	5A 250V AC	Rainproof	9,390.-
THS-8EP333	D.S.6 buttons / E. STOP, Pilot Lamp	6a	5A 250V AC	Rainproof	9,000.-
THS-8ES333	D.S.6 buttons / E. STOP, Selector	6a	5A 250V AC	Rainproof	9,030.-
THS-8EX366	D.S.2 buttons, S.S. 4 buttons / E. STOP	2a/4a	5A 250V AC	Rainproof	4,860.-
THS-8EB366	D.S.2 buttons, S.S. 4 buttons / E. STOP, P.B., SW.	2a/4a	5A 250V AC	Rainproof	4,960.-
THS-8EI366	D.S.2 buttons, S.S. 4 buttons / E. STOP, I.P.B., SW.	2a/4a	5A 250V AC	Rainproof	5,080.-
THS-8EK366	D.S.2 buttons, S.S. 4 buttons / E. STOP, Key., SW.	2a/4a	5A 250V AC	Rainproof	5,380.-
THS-8EP366	D.S.2 buttons, S.S. 4 buttons / E. STOP, Pilot Lamp	2a/4a	5A 250V AC	Rainproof	4,990.-
THS-8ES366	D.S.2 buttons, S.S. 4 buttons / E. STOP, Selector	2a/4a	5A 250V AC	Rainproof	5,020.-

tend HOIST PUSH BUTTON SWITCH

สวิตช์เครน IP67



INDIRECT OPERATION TYPE สวิตช์เครนชนิดต่อผ่านเมกนิตสวิตช์

	P/N	Description	Contact	Spec.	Remark	Price
	THS-8EX6	Indirect 2 buttons / E. STOP	2a	5A 250V AC	Rainproof	1,420.-
WIND SPEED	THS-8EB6	Indirect 2 buttons / E. STOP, P.B., SW.	2a	5A 250V AC	Rainproof	1,200.-
	THS-8EI6	Indirect 2 buttons / E. STOP, I.P.B., SW.	2a	5A 250V AC	Rainproof	1,650.-
	THS-8EK6	Indirect 2 buttons / E. STOP, Key., SW.	2a	5A 250V AC	Rainproof	1,950.-
COMMAX	THS-8EP6	Indirect 2 buttons / E. STOP, Pilot Lamp	2a	5A 250V AC	Rainproof	1,580.-
	THS-8ES6	Indirect 2 buttons / E. STOP, Selector	2a	5A 250V AC	Rainproof	1,590.-
ADVANTE	THS-8EX66	Indirect 4 buttons / E. STOP	4a	5A 250V AC	Rainproof	2,140.-
	THS-8EB66	Indirect 4 buttons / E. STOP, P.B., SW.	4a	5A 250V AC	Rainproof	2,240.-
	THS-8EI66	Indirect 4 buttons / E. STOP, I.P.B., SW.	4a	5A 250V AC	Rainproof	2,360.-
UNIVERSAL ADAPTER	THS-8EK66	Indirect 4 buttons / E. STOP, Key., SW.	4a	5A 250V AC	Rainproof	2,660.-
	THS-8EP66	Indirect 4 buttons / E. STOP, Pilot Lamp	4a	5A 250V AC	Rainproof	2,270.-
	THS-8ES66	Indirect 4 buttons / E. STOP, Selector	4a	5A 250V AC	Rainproof	2,300.-
ALION	THS-8EX666	Indirect 6 buttons / E. STOP	6a	5A 250V AC	Rainproof	2,810.-
	THS-8EB666	Indirect 6 buttons / E. STOP, P.B., SW.	6a	5A 250V AC	Rainproof	2,960.-
	THS-8EI666	Indirect 6 buttons / E. STOP, I.P.B., SW.	6a	5A 250V AC	Rainproof	3,080.-
EXOWELD	THS-8EK666	Indirect 6 buttons / E. STOP, Key., SW.	6a	5A 250V AC	Rainproof	3,380.-
	THS-8EP666	Indirect 6 buttons / E. STOP, Pilot Lamp	6a	5A 250V AC	Rainproof	2,990.-
CONTROL MAX	THS-8ES666	Indirect 6 buttons / E. STOP, Selector	6a	5A 250V AC	Rainproof	3,020.-

tend

HOIST PUSH BUTTON SWITCH

สวิตช์เครน IP67



■ DIRECT OPERATION TYPE สวิตช์เครนชนิดต่อถง

P/N	Description	Contact	Spec.	Remark	Price
THS-82	Direct Operation 2 buttons single phases	3a	15A 250V AC	Rainproof	1,400.-
THS-822	Direct Operation 4 buttons single phases	6a	15A 250V AC	Rainproof	2,670.-
THS-8222	Direct Operation 6 buttons single phases	9a	15A 250V AC	Rainproof	4,000.-
THS-82222	Direct Operation 8 buttons single phases	12a	15A 250V AC	Rainproof	6,960.-
THS-8PB2	Direct Operation 2 buttons single phases with P.B. SW. On-off	3a	15A 250V AC	Rainproof	2,470.-
THS-8PB22	Direct Operation 4 buttons single phases with P.B. SW. On-off	6a	15A 250V AC	Rainproof	4,200.-
THS-8PB222	Direct Operation 6 buttons single phases with P.B. SW. On-off	9a	15A 250V AC	Rainproof	5,910.-
THS-8EX2	Direct Operation 2 buttons with E. STOP single phases		15A 250V AC	Rainproof	2,420.-
THS-8EB2	Direct 2 buttons / E. STOP, P.B., SW. single phases		15A 250V AC	Rainproof	2,530.-
THS-8EI2	Direct 2 buttons / E. STOP, I.P.B., SW. single phases		15A 250V AC	Rainproof	2,650.-
THS-8EK2	Direct 2 buttons / E. STOP, Key., SW. single phases		15A 250V AC	Rainproof	2,950.-
THS-8EP2	Direct 2 buttons / E. STOP, Pilot Lamp single phases		15A 250V AC	Rainproof	2,560.-
THS-8ES2	Direct 2 buttons / E. STOP, Selector single phases		15A 250V AC	Rainproof	2,600.-
THS-8EX22	Direct Operation 4 buttons with E. STOP single phases		15A 250V AC	Rainproof	4,150.-
THS-8EB22	Direct 4 buttons / E. STOP, P.B., SW. single phases		15A 250V AC	Rainproof	4,250.-
THS-8EI22	Direct 4 buttons / E. STOP, I.P.B., SW. single phases		15A 250V AC	Rainproof	4,620.-
THS-8EK22	Direct 4 buttons / E. STOP, Key., SW. single phases		15A 250V AC	Rainproof	4,670.-
THS-8EP22	Direct 4 buttons / E. STOP, Pilot Lamp single phases		15A 250V AC	Rainproof	4,285.-
THS-8ES22	Direct 4 buttons / E. STOP, Selector single phases		15A 250V AC	Rainproof	4,310.-
THS-8EX222	Direct Operation 6 buttons with E. STOP single phases		15A 250V AC	Rainproof	5,870.-
THS-8EB222	Direct 6 buttons / E. STOP, P.B., SW. single phases		15A 250V AC	Rainproof	5,970.-
THS-8EI222	Direct 6 buttons / E. STOP, I.P.B., SW. single phases		15A 250V AC	Rainproof	6,100.-
THS-8EK222	Direct 6 buttons / E. STOP, Key., SW. single phases		15A 250V AC	Rainproof	6,390.-
THS-8EP222	Direct 6 buttons / E. STOP, Pilot Lamp single phases		15A 250V AC	Rainproof	6,000.-
THS-8ES222	Direct 6 buttons / E. STOP, Selector single phases		15A 250V AC	Rainproof	6,030.-

tend HOIST PUSH BUTTON SWITCH

สวิตช์เคาน์ IP67

■ Features

- This switch is waterproof and is made out of ABS housing. Suitable for out-door use.
- Sleek appearance, ergonomic, patented design.
- Unique mechanical interlock design, which can help prevent short-circuit.
- Two stage speeds can be set according to wiring configuration. First stage : inching, Second stage : rapid movement.
- Can be used with emergency stop, pilot lamp, push button switch, selector switch, key switch versatile. Selector switch rated current is 1th = 10A.
- Single speed and double speed can be chosen alternatively.

■ Characteristics

Type	Spec	External diameter of cable		Terminal	Remarks
THS94C	2A 500VAC	Two holes	Ø11.4~Ø12.6	M4	Control magnetic switch
	5A 250VAC				
THS96C	2A 500VAC	Four holes	Ø14.3~Ø15.5		

■ Model Description

	One-two holes	Three-four holes	Five-six holes	Seven-eight holes	Label
THS-9	4				None
THS-9	4	4			A
THS-9	6	6	6		
THS-9	EP	6	6	6	E

Designation	Signal	Description
Control type	4	Indirect Double Speed (Mechanical Interlock)
	6	Indirect Single Speed
Push button (ref page TA103)	EX	Emergency Stop + Waterproof Rubber
	EB	Emergency Stop + Flat Push Button Switch
	EI	Emergency Stop + Illuminated Push Button Switch
	EK	Emergency Button + Key Switch
	EP	Emergency Stop + Pilot Lamp
	ES	Emergency Stop + Selector Switch

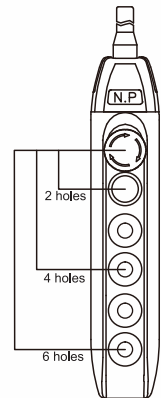

Note 1 : "None" means Chinese lable, A represents Arrow label, E represents English label see page TA121.

Note 2 : Indirect Double Speed is represented by Double Arrow labels, without additional notation of the label code A.



THS-94 □

THS-944 □

THS-9466 □

THS-9EI466 □

tend HOIST PUSH BUTTON SWITCH





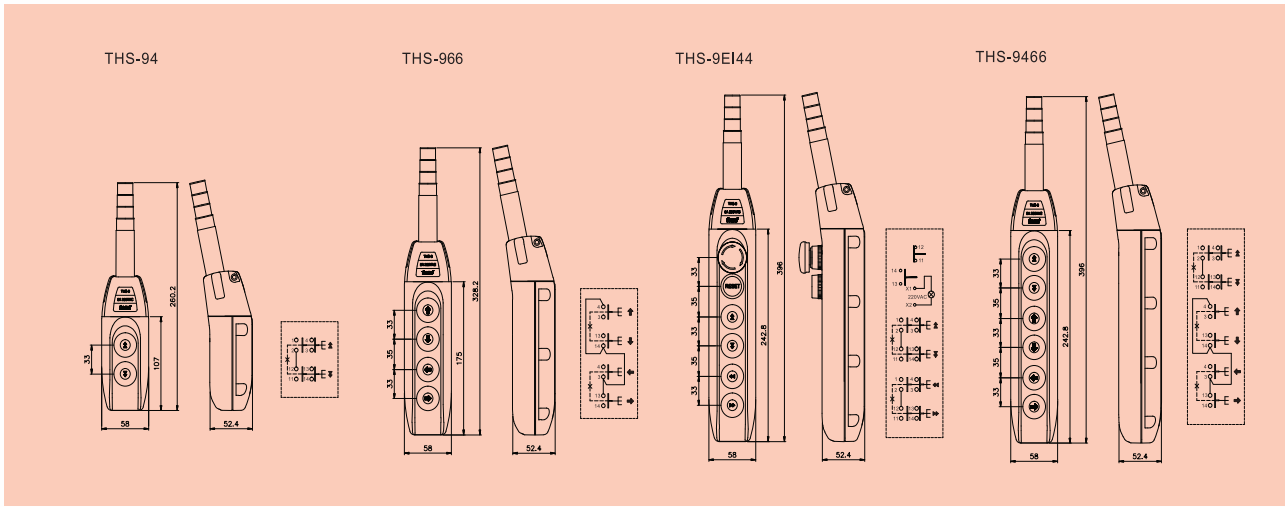

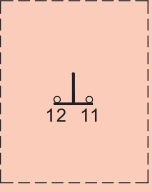

สวิตช์คอน IP67

■ DIMENSIONS AND WIRING DIAGRAMS

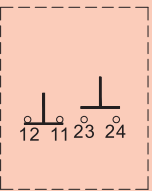

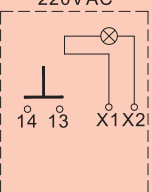

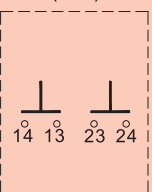
■ INDIRECT OPERATION TYPE สวิตช์คอน ชนิดต่อผ่านเมนเบ็คสวิตช์

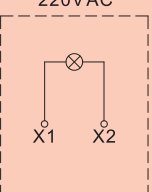
P/N	Description	Contact	Spec.	Remark	Price
THS-96	Indirect operation 2 buttons	2A	5A 250 V AC	Rainproof	650.-
THS-966	Indirect operation 4 buttons	4A	5A 250 V AC	Rainproof	1,200.-
THS-9EX6	Indirect operation 2 buttons with emergency stop	2A	5A 250 V AC	Rainproof	1,500.-
THS-9EB6	Indirect operation 2 buttons with emergency stop & flat push button	2A	5A 250 V AC	Rainproof	1,660.-
THS-9EK6	Indirect operation 2 buttons with emergency stop & key button	2A	5A 250 V AC	Rainproof	2,050.-
THS-9EP6	Indirect operation 2 buttons with emergency stop & pilot lamp	2A	5A 250 V AC	Rainproof	1,660.-
THS-9ES6	Indirect operation 2 buttons with emergency stop & selector	2A	5A 250 V AC	Rainproof	1,680.-
THS-94	Indirect operation double speed 2 buttons	2A	5A 250 V AC	Rainproof	2,900.-
THS-944	Indirect operation double speed 4 buttons	4A	5A 250 V AC	Rainproof	5,800.-
THS-9EX4	Double speed 2 buttons with emergency	2A	5A 250 V AC	Rainproof	3,590.-
THS-9EP4	Double speed 2 buttons with emergency Stop & pilot lamp	2A	5A 250 V AC	Rainproof	3,740.-
THS-9ES4	Double speed 2 buttons with emergency stop & selector	2A	5A 250 V AC	Rainproof	3,780.-

Type no.	Picture	Contact	Price
E	<p>สวิตช์กดดอกเห็ด THS-BKR</p> 	<p>(1b)</p> 	245.-
B	<p>สวิตช์กด THS-BFR</p> 	<p>(1a1b)</p> 	150.-
I	<p>สวิตช์มีไฟล๊อตแอมป์ THS-IFR</p> 	<p>(1a) 220VAC</p> 	270.-
K	<p>สวิตช์กุญแจ THS-KSR</p> 	<p>(2a)</p> 	565.-
P	<p>ไฟล๊อตแอมป์ THS-PR</p> 	<p>220VAC</p> 	180.-

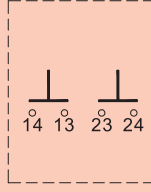
หมายเหตุ นอกเหนือจาก Spec สำเร็จรูปใน Price list นี้ ท่านสามารถซื้อ อะไหล่ประกอบเองหรือให้ทางบริษัทประกอบให้ตาม Spec ที่ต้องการ

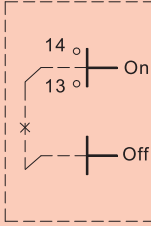
Type no.	Picture	Contact	Price
S	<p>สวิตช์ลูกศร THS-SSR</p> 	<p>(2a)</p> 	210.-
X	<p>ตัวอุด THS-X</p> 	<p>2*TP4*8 Screw Blanking Plate</p>	42.-
PB	<p>สวิตช์กด ON - OFF THS-PB</p> 	<p>(1a)</p> 	335.-

■ STICKER WITH LENS 5HS8C02

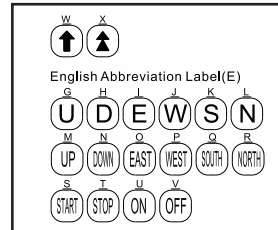

ราคาแผ่นละ 20.-

- THS-81-B-BOX FOR 2 BUTTON บ็อกสวิตช์กระแส 2 ช่อง 340.-
- THS-82-B-BOX FOR 4 BUTTON บ็อกสวิตช์กระแส 4 ช่อง 660.-
- THS-83-B-BOX FOR 6 BUTTON บ็อกสวิตช์กระแส 6 ช่อง 1,000.-
- THS-84-B-BOX FOR 8 BUTTON บ็อกสวิตช์กระแส 8 ช่อง 1,340.-
- THS-82-C CONTACT DIRECT OPERATION SINGLE SPEED คอนแทค 1 สปีดชนิดต่อตรง สำหรับรุ่น THS-82 1,340.-
- THS-83-C CONTACT INDIRECT OPERATION DOUBLE SPEED คอนแทค 2 สปีดชนิดต่อผ่านเมกเนติกสวิตช์ สำหรับรุ่น THS-83 2,340.-
- THS-86-C CONTACT INDIRECT OPERATION SINGLE SPEED คอนแทค 1 สปีดชนิดต่อผ่านเมกเนติกสวิตช์ สำหรับรุ่น THS-86 335.-

tend**HOIST PUSH BUTTON SWITCH**

สวิตช์เครน IP67

INDIRECT OPERATION TYPE สวิตช์เครนชนิดต่อผ่านเมกเนติกสวิตช์

	P/N	Description	Contact	Spec.	Remark	Price
	THS-86	Indirect Operation 2 buttons	2a	5A 250V AC	Rainproof	600.-
WIND SPEED	THS-866	Indirect Operation 4 buttons	4a	5A 250V AC	Rainproof	1,050.-
	THS-8666	Indirect Operation 6 buttons	6a	5A 250V AC	Rainproof	1,450.-
COMMAX	THS-86666	Indirect Operation 8 buttons	8a	5A 250V AC	Rainproof	2,830.-
	THS-8PB6	Indirect Operation 2 buttons with P.B.SW. on-Off	2a	5A 250V AC	Rainproof	1,470.-
	THS-8PB66	Indirect Operation 4 buttons with P.B.SW. on-Off	4a	5A 250V AC	Rainproof	2,180.-
ADVANTE	THS-8PB666	Indirect Operation 6 buttons with P.B.SW. on-Off	6a	5A 250V AC	Rainproof	2,900.-
	THS-83	Indirect Operation Double Speed 2 buttons	2a	5A 250V AC	Rainproof	2,820.-
	THS-833	Indirect Operation Double Speed 4 buttons	4a	5A 250V AC	Rainproof	5,520.-
UNIVERSAL ADAPTER	THS-8333	Indirect Operation Double Speed 6 buttons	6a	5A 250V AC	Rainproof	8,360.-
	THS-83333	Indirect Operation Double Speed 8 buttons	8a	5A 250V AC	Rainproof	10,960.-
ALION	THS-8PB3	Indirect Operation Double Speed 2 buttons with P.B.SW. on-off	2a	5A 250V AC	Rainproof	3,470.-
	THS-8PB33	Indirect Operation Double Speed 4 buttons with P.B.SW. on-off	4a	5A 250V AC	Rainproof	6,200.-
	THS-8PB333	Indirect Operation Double Speed 6 buttons with P.B.SW. on-off	6a	5A 250V AC	Rainproof	8,810.-
EXOWELD	THS-836	Double Speed 2 buttons Single Speed 2 buttons	2a	5A 250V AC	Rainproof	3,510.-
	THS-8366	Double Speed 2 buttons Single Speed 4 buttons	4a	5A 250V AC	Rainproof	4,230.-
	THS-8336	Double Speed 4 buttons Single Speed 2 buttons	6a	5A 250V AC	Rainproof	6,230.-
	THS-83666	Double Speed 2 buttons Single Speed 6 buttons	6a	5A 250V AC	Rainproof	4,940.-
CONTROL MAX	THS-83366	Double Speed 4 buttons Single Speed 4 buttons	6a	5A 250V AC	Rainproof	6,950.-
	THS-83336	Double Speed 6 buttons Single Speed 2 buttons	8a	5A 250V AC	Rainproof	8,950.-
	THS-8EX3	Double Speed 2 buttons With Emergency Stop	2a	5A 250V AC	Rainproof	3,420.-
JKN	THS-8EB3	Double Speed 2 buttons With Emergency Stop, P.B. SW	2a	5A 250V AC	Rainproof	3,530.-
	THS-8EI3	Double Speed 2 buttons With Emergency Stop, I. P.B SW	2a	5A 250V AC	Rainproof	3,630.-
SYLVIA	THS-8EK3	Double Speed 2 buttons With Emergency Stop & Key Sw.	2a	5A 250V AC	Rainproof	3,950.-
	THS-8EP3	Double Speed 2 buttons With Emergency Stop & Pilot Lamp	2a	5A 250V AC	Rainproof	3,560.-
WANG	THS-8ES3	Double Speed 2 buttons With Emergency Stop & Selector	2a	5A 250V AC	Rainproof	3,600.-

*ขอสงวนสิทธิ์ในการเปลี่ยนแปลงราคา



INDIRECT OPERATION TYPE สวิตช์เครนชนิดต่อผ่านเมกเนติกสวิตช์

P/N	Description	Contact	Spec.	Remark	Price
THS-8EX36	D.S.2 buttons, S.S. 2 buttons / E. STOP	2a/2a	5A 250V AC	Rainproof	4,140.-
THS-8EB36	D.S.2 buttons, S.S. 2 buttons / E. STOP, P.B., SW.	2a/2a	5A 250V AC	Rainproof	4,250.-
THS-8EI36	D.S.2 buttons, S.S. 2 buttons / E. STOP, I.P.B., SW.	2a/2a	5A 250V AC	Rainproof	4,370.-
THS-8EK36	D.S.2 buttons, S.S. 2 buttons / E. STOP, Key., SW.	2a/2a	5A 250V AC	Rainproof	4,660.-
THS-8EP36	D.S.2 buttons, S.S. 2 buttons / E. STOP, Pilot Lamp	2a/2a	5A 250V AC	Rainproof	4,280.-
THS-8ES36	D.S.2 buttons, S.S. 2 buttons / E. STOP, Selector	2a/2a	5A 250V AC	Rainproof	4,310.-
THS-8EX33	D.S.4 buttons, B1 / E. STOP	4a	5A 250V AC	Rainproof	6,150.-
THS-8EB33	D.S.4 buttons / E. STOP, P.B., SW.	4a	5A 250V AC	Rainproof	6,250.-
THS-8EI33	D.S.4 buttons / E. STOP, I.P.B., SW.	4a	5A 250V AC	Rainproof	6,370.-
THS-8EK33	D.S.4 buttons / E. STOP, Key., SW.	4a	5A 250V AC	Rainproof	6,670.-
THS-8EP33	D.S.4 buttons / E. STOP, Pilot Lamp	4a	5A 250V AC	Rainproof	6,280.-
THS-8ES33	D.S.4 buttons / E. STOP, Selector	4a	5A 250V AC	Rainproof	6,210.-
THS-8EX336	D.S.4 buttons, S.S. 2 buttons / E. STOP	4a/2a	5A 250V AC	Rainproof	6,860.-
THS-8EB336	D.S.4 buttons, S.S. 2 buttons / E. STOP, P.B., SW.	4a/2a	5A 250V AC	Rainproof	6,970.-
THS-8EI336	D.S.4 buttons, S.S. 2 buttons / E. STOP, I.P.B., SW.	4a/2a	5A 250V AC	Rainproof	7,090.-
THS-8EK336	D.S.4 buttons, S.S. 2 buttons / E. STOP, Key., SW.	4a/2a	5A 250V AC	Rainproof	7,380.-
THS-8EP336	D.S.4 buttons, S.S. 2 buttons / E. STOP, Pilot Lamp	4a/2a	5A 250V AC	Rainproof	7,000.-
THS-8ES336	D.S.4 buttons, S.S. 2 buttons / E. STOP, Selector	4a/2a	5A 250V AC	Rainproof	7,030.-
THS-8EX333	THS-8EX333 D.S.6 buttons, B1 / E. STOP	6a	5A 250V AC	Rainproof	8,870.-
THS-8EB333	D.S.6 buttons / E. STOP, P.B., SW.	6a	5A 250V AC	Rainproof	8,970.-
THS-8EI333	D.S.6 buttons / E. STOP, I.P.B., SW.	6a	5A 250V AC	Rainproof	9,090.-
THS-8EK333	D.S.6 buttons / E. STOP, Key., SW.	6a	5A 250V AC	Rainproof	9,390.-
THS-8EP333	D.S.6 buttons / E. STOP, Pilot Lamp	6a	5A 250V AC	Rainproof	9,000.-
THS-8ES333	D.S.6 buttons / E. STOP, Selector	6a	5A 250V AC	Rainproof	9,030.-
THS-8EX366	D.S.2 buttons, S.S. 4 buttons / E. STOP	2a/4a	5A 250V AC	Rainproof	4,860.-
THS-8EB366	D.S.2 buttons, S.S. 4 buttons / E. STOP, P.B., SW.	2a/4a	5A 250V AC	Rainproof	4,960.-
THS-8EI366	D.S.2 buttons, S.S. 4 buttons / E. STOP, I.P.B., SW.	2a/4a	5A 250V AC	Rainproof	5,080.-
THS-8EK366	D.S.2 buttons, S.S. 4 buttons / E. STOP, Key., SW.	2a/4a	5A 250V AC	Rainproof	5,380.-
THS-8EP366	D.S.2 buttons, S.S. 4 buttons / E. STOP, Pilot Lamp	2a/4a	5A 250V AC	Rainproof	4,990.-
THS-8ES366	D.S.2 buttons, S.S. 4 buttons / E. STOP, Selector	2a/4a	5A 250V AC	Rainproof	5,020.-

tend HOIST PUSH BUTTON SWITCH

สวิตช์เครน IP67



INDIRECT OPERATION TYPE สวิตช์เครนชนิดต่อผ่านเมกนติกสวิตช์

	P/N	Description	Contact	Spec.	Remark	Price
	THS-8EX6	Indirect 2 buttons / E. STOP	2a	5A 250V AC	Rainproof	1,420.-
WIND SPEED	THS-8EB6	Indirect 2 buttons / E. STOP, P.B., SW.	2a	5A 250V AC	Rainproof	1,200.-
	THS-8EI6	Indirect 2 buttons / E. STOP, I.P.B., SW.	2a	5A 250V AC	Rainproof	1,650.-
	THS-8EK6	Indirect 2 buttons / E. STOP, Key., SW.	2a	5A 250V AC	Rainproof	1,950.-
COMMAX	THS-8EP6	Indirect 2 buttons / E. STOP, Pilot Lamp	2a	5A 250V AC	Rainproof	1,580.-
	THS-8ES6	Indirect 2 buttons / E. STOP, Selector	2a	5A 250V AC	Rainproof	1,590.-
ADVANTE	THS-8EX66	Indirect 4 buttons / E. STOP	4a	5A 250V AC	Rainproof	2,140.-
	THS-8EB66	Indirect 4 buttons / E. STOP, P.B., SW.	4a	5A 250V AC	Rainproof	2,240.-
	THS-8EI66	Indirect 4 buttons / E. STOP, I.P.B., SW.	4a	5A 250V AC	Rainproof	2,360.-
UNIVERSAL ADAPTER	THS-8EK66	Indirect 4 buttons / E. STOP, Key., SW.	4a	5A 250V AC	Rainproof	2,660.-
	THS-8EP66	Indirect 4 buttons / E. STOP, Pilot Lamp	4a	5A 250V AC	Rainproof	2,270.-
	THS-8ES66	Indirect 4 buttons / E. STOP, Selector	4a	5A 250V AC	Rainproof	2,300.-
ALION	THS-8EX666	Indirect 6 buttons / E. STOP	6a	5A 250V AC	Rainproof	2,810.-
	THS-8EB666	Indirect 6 buttons / E. STOP, P.B., SW.	6a	5A 250V AC	Rainproof	2,960.-
	THS-8EI666	Indirect 6 buttons / E. STOP, I.P.B., SW.	6a	5A 250V AC	Rainproof	3,080.-
EXOWELD	THS-8EK666	Indirect 6 buttons / E. STOP, Key., SW.	6a	5A 250V AC	Rainproof	3,380.-
	THS-8EP666	Indirect 6 buttons / E. STOP, Pilot Lamp	6a	5A 250V AC	Rainproof	2,990.-
CONTROL MAX	THS-8ES666	Indirect 6 buttons / E. STOP, Selector	6a	5A 250V AC	Rainproof	3,020.-

tend

HOIST PUSH BUTTON SWITCH

สวิตช์เครน IP67



■ DIRECT OPERATION TYPE สวิตช์เครนชนิดต่อถง

P/N	Description	Contact	Spec.	Remark	Price
THS-82	Direct Operation 2 buttons single phases	3a	15A 250V AC	Rainproof	1,400.-
THS-822	Direct Operation 4 buttons single phases	6a	15A 250V AC	Rainproof	2,670.-
THS-8222	Direct Operation 6 buttons single phases	9a	15A 250V AC	Rainproof	4,000.-
THS-82222	Direct Operation 8 buttons single phases	12a	15A 250V AC	Rainproof	6,960.-
THS-8PB2	Direct Operation 2 buttons single phases with P.B. SW. On-off	3a	15A 250V AC	Rainproof	2,470.-
THS-8PB22	Direct Operation 4 buttons single phases with P.B. SW. On-off	6a	15A 250V AC	Rainproof	4,200.-
THS-8PB222	Direct Operation 6 buttons single phases with P.B. SW. On-off	9a	15A 250V AC	Rainproof	5,910.-
THS-8EX2	Direct Operation 2 buttons with E. STOP single phases		15A 250V AC	Rainproof	2,420.-
THS-8EB2	Direct 2 buttons / E. STOP, P.B., SW. single phases		15A 250V AC	Rainproof	2,530.-
THS-8EI2	Direct 2 buttons / E. STOP, I.P.B., SW. single phases		15A 250V AC	Rainproof	2,650.-
THS-8EK2	Direct 2 buttons / E. STOP, Key., SW. single phases		15A 250V AC	Rainproof	2,950.-
THS-8EP2	Direct 2 buttons / E. STOP, Pilot Lamp single phases		15A 250V AC	Rainproof	2,560.-
THS-8ES2	Direct 2 buttons / E. STOP, Selector single phases		15A 250V AC	Rainproof	2,600.-
THS-8EX22	Direct Operation 4 buttons with E. STOP single phases		15A 250V AC	Rainproof	4,150.-
THS-8EB22	Direct 4 buttons / E. STOP, P.B., SW. single phases		15A 250V AC	Rainproof	4,250.-
THS-8EI22	Direct 4 buttons / E. STOP, I.P.B., SW. single phases		15A 250V AC	Rainproof	4,620.-
THS-8EK22	Direct 4 buttons / E. STOP, Key., SW. single phases		15A 250V AC	Rainproof	4,670.-
THS-8EP22	Direct 4 buttons / E. STOP, Pilot Lamp single phases		15A 250V AC	Rainproof	4,285.-
THS-8ES22	Direct 4 buttons / E. STOP, Selector single phases		15A 250V AC	Rainproof	4,310.-
THS-8EX222	Direct Operation 6 buttons with E. STOP single phases		15A 250V AC	Rainproof	5,870.-
THS-8EB222	Direct 6 buttons / E. STOP, P.B., SW. single phases		15A 250V AC	Rainproof	5,970.-
THS-8EI222	Direct 6 buttons / E. STOP, I.P.B., SW. single phases		15A 250V AC	Rainproof	6,100.-
THS-8EK222	Direct 6 buttons / E. STOP, Key., SW. single phases		15A 250V AC	Rainproof	6,390.-
THS-8EP222	Direct 6 buttons / E. STOP, Pilot Lamp single phases		15A 250V AC	Rainproof	6,000.-
THS-8ES222	Direct 6 buttons / E. STOP, Selector single phases		15A 250V AC	Rainproof	6,030.-

tend HOIST PUSH BUTTON SWITCH

สวิตช์เคาน์ IP67

■ Features

- This switch is waterproof and is made out of ABS housing. Suitable for out-door use.
- Sleek appearance, ergonomic, patented design.
- Unique mechanical interlock design, which can help prevent short-circuit.
- Two stage speeds can be set according to wiring configuration. First stage : inching, Second stage : rapid movement.
- Can be used with emergency stop, pilot lamp, push button switch, selector switch, key switch versatile. Selector switch rated current is 1th = 10A.
- Single speed and double speed can be chosen alternatively.

■ Characteristics

Type	Spec	External diameter of cable		Terminal	Remarks
THS94C	2A 500VAC	Two holes	Ø11.4~Ø12.6	M4	Control magnetic switch
	5A 250VAC				
THS96C	2A 500VAC	Four holes	Ø14.3~Ø15.5		

■ Model Description

	One-two holes	Three-four holes	Five-six holes	Seven-eight holes	Label
THS-9	4				None
THS-9	4	4			A
THS-9	6	6	6		
THS-9	EP	6	6	6	E

Designation	Signal	Description
Control type	4	Indirect Double Speed (Mechanical Interlock)
	6	Indirect Single Speed
Push button (ref page TA103)	EX	Emergency Stop + Waterproof Rubber
	EB	Emergency Stop + Flat Push Button Switch
	EI	Emergency Stop + Illuminated Push Button Switch
	EK	Emergency Button + Key Switch
	EP	Emergency Stop + Pilot Lamp
	ES	Emergency Stop + Selector Switch

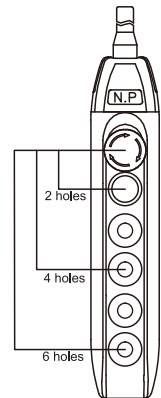

Note 1 : "None" means Chinese lable, A represents Arrow label, E represents English label see page TA121.

Note 2 : Indirect Double Speed is represented by Double Arrow labels, without additional notation of the label code A.



THS-94 □

THS-944 □

THS-9466 □

THS-9EI466 □

tend HOIST PUSH BUTTON SWITCH

สวิตช์คอน IP67

■ DIMENSIONS AND WIRING DIAGRAMS

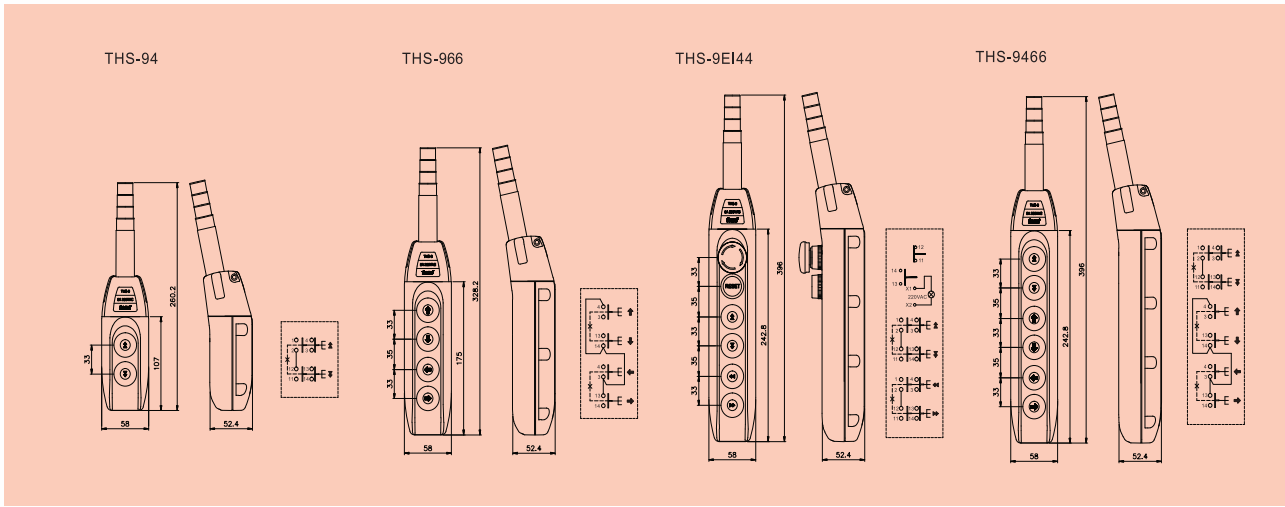

■ INDIRECT OPERATION TYPE สวิตช์คอน ชนิดต่อผ่านเมนเทคสวิตช์

P/N	Description	Contact	Spec.	Remark	Price
THS-96	Indirect operation 2 buttons	2A	5A 250 V AC	Rainproof	650.-
THS-966	Indirect operation 4 buttons	4A	5A 250 V AC	Rainproof	1,200.-
THS-9EX6	Indirect operation 2 buttons with emergency stop	2A	5A 250 V AC	Rainproof	1,500.-
THS-9EB6	Indirect operation 2 buttons with emergency stop & flat push button	2A	5A 250 V AC	Rainproof	1,660.-
THS-9EK6	Indirect operation 2 buttons with emergency stop & key button	2A	5A 250 V AC	Rainproof	2,050.-
THS-9EP6	Indirect operation 2 buttons with emergency stop & pilot lamp	2A	5A 250 V AC	Rainproof	1,660.-
THS-9ES6	Indirect operation 2 buttons with emergency stop & selector	2A	5A 250 V AC	Rainproof	1,680.-
THS-94	Indirect operation double speed 2 buttons	2A	5A 250 V AC	Rainproof	2,900.-
THS-944	Indirect operation double speed 4 buttons	4A	5A 250 V AC	Rainproof	5,800.-
THS-9EX4	Double speed 2 buttons with emergency	2A	5A 250 V AC	Rainproof	3,590.-
THS-9EP4	Double speed 2 buttons with emergency Stop & pilot lamp	2A	5A 250 V AC	Rainproof	3,740.-
THS-9ES4	Double speed 2 buttons with emergency stop & selector	2A	5A 250 V AC	Rainproof	3,780.-